



# Iluminación para el automóvil







Catálogo 2019



## ¿Qué solución de iluminación necesita?

### Soluciones halógenas de 12V



Sustitución	Durabilidad	Más visibilidad		Estilo		
<b>Standard</b> Buena relación calidad-precio  Disponible en H1, H2, H3, H4, H7, H8, H9, H10, H13, H15, R2, H27W, S2, HB1, HB2, HB3, HB4, HB5	<b>Long Life</b> Doble vida útil  Disponible en H1, H4, H7, H11, H6W, 862	<b>Range Power 50+</b> Hasta un 50% más visibilidad  Disponible en H1, H3, H4, H7	<b>Range Power 110</b> Hasta un 110% más visibilidad  Disponible en H4, H7	<b>Range Power Blue+</b> Hasta un 50% más visibilidad, elegante blanco  Disponible en H1, H3, H4, H7, HB2, HB3, HB4, HB5	<b>Range Power White</b> 4 500 K de xenón blanco  Sin homologación ECE* Disponible en H1, H3, H4, H7, HB3, HB4, W5W kits	<b>Rallye</b> Excelente luminosidad  Sin homologación ECE* Disponible en H1, H2, H3, H4, H7, HB1, HB3, HB4, HB5

### Soluciones halógenas de 24V



Sustitución	Durabilidad	Estilo
<b>Standard</b> Buena relación calidad-precio  Disponible en H1, H2, H3, H4, H7, R2, R2 halógena	<b>Heavy Duty</b> Resiste todas las vibraciones  Disponible en H1, H3, H4, H7	<b>Rallye</b> Excelente luminosidad  Sin homologación ECE* Disponible en H1, H3, H4

### Soluciones de Xenón



#### Lámparas de descarga de alta intensidad

#### Tecnología HID

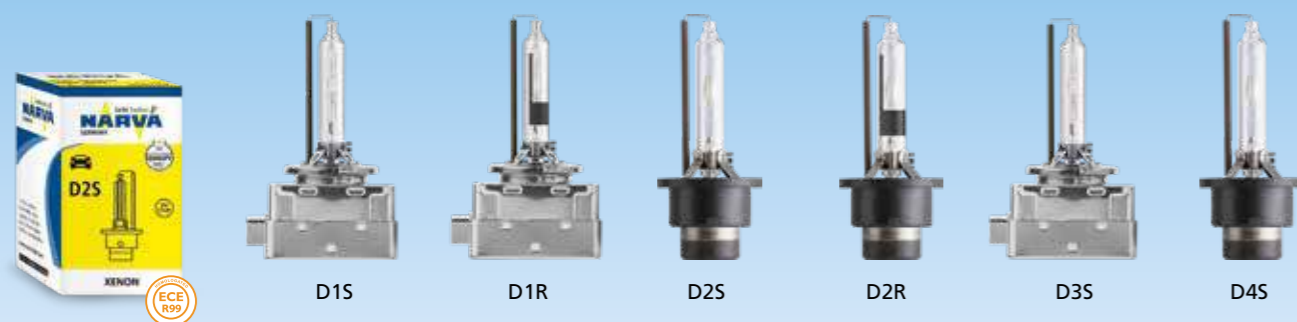

### Soluciones de LED



#### LED

#### LED retrofit

#### Range Power LED



\*Importante En Europa se prohíbe la venta de productos que no lleven el logotipo de certificación ECE y no estén homologados.



Es su propia responsabilidad usar las luces LED retrofit conforme con los requisitos legales aplicables.

## 12V Soluciones halógenas

### LÁMPARAS DELANTERAS

■ **Sustitución**

10 | Standard

■ **Durabilidad**

12 | Long Life

■ **Más visibilidad**

13 | Range Power 50+

13 | Range Power 110

■ **Estilo**

14 | Range Power Blue+

15 | Range Power White

16 | Rallye

17 | Tipos americanos

### SEÑALIZACIÓN E ILUMINACIÓN DE INTERIOR

■ **Sustitución**

20 | Lámparas de señalización

22 | Lámparas halógenas en miniatura

22 | Lámparas indicadoras de base en cuña

24 | Lámparas Festoon

25 | Lámparas con base plástica (Bax)

■ **Estilo**

27 | Range Power Blue+

27 | Tipos americanos

28 | ¿Qué tipo de lámpara de 12V necesita?

### KITS DE REPUESTOS Y HERRAMIENTAS DE VENTAS

30 | Kits de repuestos

31 | Kit Range Power White

32 | Caja Bax

32 | Herramientas de ventas

## 12V Soluciones LED

### LÁMPARAS DELANTERAS

34 | LED-HL [≈H4]

LED-HL [≈H7]

LED-FOG [≈H8/H11/H16]

LED-HL [≈HB3/HB4]

LED-HL [≈HIR2]

LED-HL [≈H11]

### SEÑALIZACIÓN E ILUMINACIÓN DE INTERIOR

35 | LED-T10 [≈W5W]

LED-FEST 38mm

LED-RED [P21W]

LED-RED [P21/5W]

LED-T20-RED [W21/5W]

## Soluciones xenón

38 | NARVA HID Lámparas delanteras

## 24V Soluciones halógenas

### LÁMPARAS DELANTERAS

■ **Sustitución**

40 | Standard

■ **Durabilidad**

41 | Heavy Duty

■ **Estilo**

41 | Rallye

### SEÑALIZACIÓN E ILUMINACIÓN DE INTERIOR

■ **Sustitución**

42 | Lámparas de señalización

43 | Lámparas halógenas en miniatura

44 | Lámparas indicadoras de base en cuña

44 | Lámparas Festoon

45 | Lámparas con base plástica (Bax)

■ **Durabilidad**

46 | Heavy Duty

47 | ¿Qué tipo de lámpara de 24V necesita?

### KITS DE REPUESTOS Y HERRAMIENTAS DE VENTAS

48 | Kits de repuestos

49 | Herramientas de ventas

## Iluminación para vehículos de dos ruedas

### LÁMPARAS DELANTERAS

■ **Sustitución**

50 | Standard

51 | ¿Qué tipo de lámpara para vehículos de dos ruedas necesita?

### Nuestros clientes son lo primero

En NARVA, la satisfacción de los clientes es nuestra principal prioridad. NARVA suministra productos de iluminación para automoción de alta calidad para que los profesionales puedan satisfacer plenamente las necesidades de sus clientes. Con NARVA, los talleres y las tiendas pueden prestar un servicio y entregar productos de calidad a un precio asequible.

NARVA ha desarrollado una completa cartera de productos para atender las necesidades de profesionales de todo el mundo. Los equipos y distribuidores especiales de NARVA están dedicados a la tarea de atender e informar a nuestros clientes internacionales. Trabajamos para atender con eficiencia y eficacia las exigencias de todos los clientes y mercados, en todas las áreas de nuestro negocio. Nuestras oficinas de ventas en colaboración con un almacén central, ofrecen un cordial servicio de atención al

cliente y un servicio de entregas muy eficiente.

Los equipos y distribuidores especiales de NARVA están dedicados a la tarea de proporcionar un servicio extraordinario a los clientes en todas las áreas de nuestro negocio.

Mostramos nuestra preocupación por nuestros clientes ofreciéndoles un **producto de calidad** a un **precio asequible**.

A medida que las carreteras actuales están cada vez más congestionadas, creemos que es necesario que todos los conductores puedan permitirse una solución de iluminación fiable y de alta calidad para una mayor seguridad y visibilidad.

**Iluminación de calidad a un precio asequible, ahora al alcance de todos.**



### Nuestra calidad asequible

#### Productos NARVA: calidad constante y fiabilidad

- NARVA, más de 65 años de experiencia en iluminación del automóvil
- Pruebas exhaustivas durante todo el proceso de producción
- Control de calidad constante de todas y cada una de las lámparas
- Cumplimiento de pruebas y procesos de certificación internacional, como ISO/TS 16949, DIN EN ISO 14001, ECE 37.
- Inversión permanente en innovación de productos y procesos nuevos

Nuestros productos cumplen las normas ECE\* y otros requisitos legales. (Consulte *¿Qué solución de iluminación necesita?* en la página 2 para descubrir todos los productos de iluminación certificados ECE).

La producción de NARVA, así como los procesos de marketing

y logística, se someten a controles periódicos con ayuda de las normas internacionales ISO\*\* de ingeniería más actuales. ECE creó unas directrices internacionales para el sector de automoción y sus proveedores, con el objetivo de reducir las barreras comerciales y aumentar la seguridad del tráfico. En Europa se prohíbe la venta de productos no conformes con las normas ECE.

Los productos NARVA cumplen las normas ECE 37 y 99 que proporcionan directrices, como medidas, flujo luminoso y potencia, para las lámparas de filamento.

La ISO/TS 16949 es la prueba de nuestra sólida integración de la seguridad y la estabilidad en los procesos de producción, marketing y logística.

Los más de 65 años de experiencia y especialización definen a todas las soluciones de iluminación de NARVA. NARVA siempre está sometiendo sus productos de iluminación para la automoción a pruebas, a fin de mejorar y asegurar la calidad constante de los mismos. El cumplimiento de todas las pruebas de calidad garantiza la fiabilidad de todos los productos NARVA.



Sistema de gestión acreditado  
DIN ISO/TS 16949  
DIN EN ISO 9001  
para ventas y producción  
DIN EN ISO 14001



\*ECE = Economic Commission for Europe (comisión económica para Europa)  
\*\*ISO = International Organization for Standardization (organización internacional para la normalización)

Si desea más información sobre NARVA, visite nuestra página web en [www.narva-light.com](http://www.narva-light.com)

# 12V Soluciones halógenas

NARVA es reconocido por fabricar soluciones de iluminación de calidad y duraderas que proporcionan una mayor visibilidad y seguridad en todas las condiciones de conducción. Descubra nuestra gama completa de iluminación para automoción incluidas nuestras lámparas de interior de LED.

## ■ Sustitución

### Standard

NARVA Standard es la gama estándar de NARVA. Representa la mejor relación calidad precio y combina fiabilidad y economía. Para conductores que busquen la mejor relación de calidad y rendimiento sin sacrificar la seguridad, NARVA Standard es la elección adecuada.



Obtenga más información sobre Standard

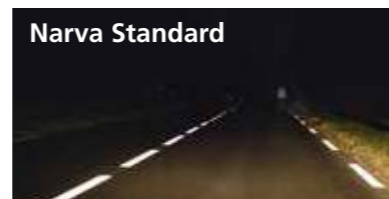

## ■ Durabilidad

### Long Life

Nuestra gama Long Life ha sido especialmente diseñada para una larga duración. Duran dos veces más que las lámparas estándar; no será preciso cambiar estas bombillas de larga duración con tanta frecuencia lo que implica un menor mantenimiento a la par que un mínimo impacto en el medioambiente.



Obtenga más información sobre Long Life



## ■ Más visibilidad

### Range Power 50+

Con una visión hasta un 50% superior que una lámpara estándar, nuestra gama Range Power 50+ consigue un haz de luz más largo para un brillo aún mayor. Está diseñada para que los conductores vean más lejos y con más claridad para una mayor seguridad.



Obtenga más información sobre Range Power 50+



Estándar Mercado

Range Power 50+



Estándar Mercado

Range Power 110



### Range Power 110

La nueva gama Range Power 110 ofrece hasta un 110% más visibilidad. El potente haz de luz permite a los conductores ver más lejos. El diseño especial de quemador genera una potencia lumínica más alta para una mayor seguridad y un rendimiento superior.



Obtenga más información sobre Range Power 110



## ■ Estilo

### Range Power Blue+

Emite hasta un 50% más visibilidad y hasta un 30% de elegante luz más fría. Nuestra gama Range Power Blue+ ha sido diseñada para que los conductores vean más lejos y con mayor claridad, para una mayor visibilidad y seguridad. El elegante efecto azul hará que cualquier coche destaque sobre los demás.



Obtenga más información sobre Range Power Blue+



Estándar Mercado

Range Power Blue+



Estándar Mercado

Range Power White

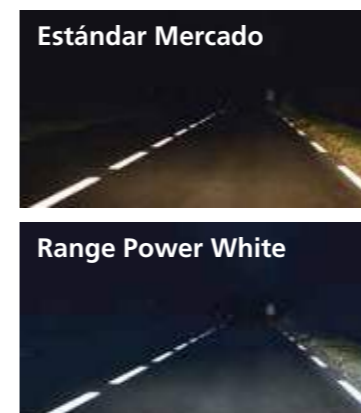

### Range Power White\*

La gama Range Power White de NARVA proporciona una luz blanca brillante y elegante. Con el elegante efecto de xenón, conseguido gracias a la temperatura de color de 4 500 K, el automóvil adquiere un llamativo aspecto próximo a la luz diurna. Range Power White es la opción que elegida por los que desean destacar sobre los demás.

\*Sin homologación ECE.  
No se puede vender ni utilizar en Europa.





# 12V Lámparas delanteras



La lámpara gama **Standard** es perfecta para conductores que deseen cambiar una bombilla fundida.

Para quienes deseen una lámpara más respetuosa con el medioambiente, nuestra gama **Long Life** ofrece doble vida útil.

Para conductores exigentes que buscan una lámpara de alto rendimiento, descubra nuestra gama **Range Power 50+**,

que cuenta con una visión hasta un 50% superior.

La nueva gama **Range Power 110** ofrece hasta un 110% más visibilidad. El potente haz de luz permite a los conductores ver más lejos.

Por último la gama **Range Power Blue+** combina una brillante luz blanca con un efecto azul para un rendimiento elegante.

## Sustitución

### STANDARD

*Buena relación calidad-precio*

ECE	Nº de ref.	V	W	Base	Piezas por unidad	Embalaje
 H1	483203000	12	55	P14,5s	100	C1
	483204000	12	55	P14,5s	10	B1

ECE	Nº de ref.	V	W	Base	Piezas por unidad	Embalaje
 H2	484203000	12	55	X511	100	C1

ECE	Nº de ref.	V	W	Base	Piezas por unidad	Embalaje
 H3	483213000	12	55	PK22s	100	C1
	483214000	12	55	PK22s	10	B1

ECE	Nº de ref.	V	W	Base	Piezas por unidad	Embalaje
 H4	488813000	12	60/55	P43t	100	C1
	488814000	12	60/55	P43t-38	10	B1

ECE	Nº de ref.	V	W	Base	Piezas por unidad	Embalaje
 H7	483283000	12	55	PX26d	100	C1
	483284000	12	55	PX26d	10	B1

ECE	Nº de ref.	V	W	Base	Piezas por unidad	Embalaje
 H8	480763000	12	35	PGJ19-1	100	C1

ECE	Nº de ref.	V	W	Base	Piezas por unidad	Embalaje
 H9	480773000	12	65	PGJ19-5	100	C1

ECE	Nº de ref.	V	W	Base	Piezas por unidad	Embalaje
 H10 (9145)	480953000	12	42	PY20d	100	C1

ECE	Nº de ref.	V	W	Base	Piezas por unidad	Embalaje
 H13 (9008)	480923000	12	60/55	P26,4t	100	C1

ECE	Nº de ref.	V	W	Base	Piezas por unidad	Embalaje
 H15	480703000	12	15/55	PGJ23t-1	100	C1

ECE	Nº de ref.	V	W	Base	Piezas por unidad	Embalaje
 R2 Halogen	481213000	12	45/40	P45t-41	100	C1





ECE	Nº de ref.	V	W	Base	Piezas por unidad	Embalaje
 R2	492113000	12	45/40	P45t	100	C1

ECE	Nº de ref.	V	W	Base	Piezas por unidad	Embalaje
 H27W/1	480413000	12	27	PG13	100	C1

ECE	Nº de ref.	V	W	Base	Piezas por unidad	Embalaje
 H27W/2	480423000	12	27	PGJ13	100	C1

ECE	Nº de ref.	V	W	Base	Piezas por unidad	Embalaje
 S2	495313000	12	35/35	BA20d	200	C1







ECE	Nº de ref.	V	W	Base	Piezas por unidad	Embalaje
 <b>HB1</b>	<b>48004</b> 3000	12	65/45	P29t	100	CP
 <b>HB2</b>	<b>48882</b> 3000	12	67/60	P43t-38	100	C1
 <b>HB3</b>	<b>48005</b> 3000	12	60	P20d	100	C1
	<b>48005</b> 4000	12	60	P20d	10	B1
 <b>HB4</b>	<b>48006</b> 3000	12	51	P22d	100	C1
	<b>48006</b> 4000	12	51	P22d	10	B1
 <b>HB5</b>	<b>48007</b> 3000	12	65/55	PX29t	100	C1

## Durabilidad

LONG LIFE





Doble vida útil

ECE	Nº de ref.	V	W	Base	Piezas por unidad	Embalaje
 <b>H1 LL</b>	<b>48322</b> 3000	12	55	P14,5s	100	C1
 <b>H4 LL</b>	<b>48889</b> 3000	12	60/55	P43t-38	100	C1
 <b>H7 LL</b>	<b>48329</b> 3000	12	55	PX26d	100	C1
 <b>H11 LL</b>	<b>48078</b> 3000	12	55	PGJ19-2	100	C1
 <b>862 LL</b>	<b>48059</b> 5000	12	37.5	PGJ13	300	CP

## Más visibilidad



RANGE POWER 50+

Hasta un 50% más visibilidad

ECE	Nº de ref.	V	W	Base	Piezas por unidad	Embalaje
 <b>H1 RP50+</b>	<b>48334</b> 3000	12	55	P14,5s	100	C1
	<b>48334</b> 4000	12	55	P14,5s	10	B1
	<b>48334</b> 2100	12	55	P14,5s	10	S2
 <b>H3 RP50+</b>	<b>48335</b> 3000	12	55	PK22s	100	C1
 <b>H4 RP50+</b>	<b>48861</b> 3000	12	60/55	P43t-38	100	C1
	<b>48861</b> 4000	12	60/55	P43t-38	10	B1
	<b>48861</b> 2100	12	60/55	P43t-38	10	S2
 <b>H7 RP50+</b>	<b>48339</b> 3000	12	55	PX26d	100	C1
	<b>48339</b> 4000	12	55	PX26d	10	B1
	<b>48339</b> 2100	12	55	PX26d	10	S2

RANGE POWER 110

Hasta un 110% más visibilidad

ECE	Nº de ref.	V	W	Base	Piezas por unidad	Embalaje
 <b>H4 RP110</b>	<b>48061</b> 3000	12	60/55	P43t-38	100	C1
	<b>48061</b> 2100	12	60/55	P43t-38	10	S2
 <b>H7 RP110</b>	<b>48062</b> 3000	12	55	PX26d	100	C1
	<b>48062</b> 2100	12	55	PX26d	10	S2





## Estilo

### RANGE POWER BLUE+

Hasta un 50% más visibilidad, elegante blanco

ECE	Nº de ref.	V	W	Base	Piezas por unidad	Embalaje	
	<b>H1</b>	<b>486303000</b>	12	55	P14,5s	100	C1
	<b>RPB+</b>	<b>486304000</b>	12	55	P14,5s	10	B1
	<b>486302100</b>	12	55	P14,5s	10	S2	

ECE	Nº de ref.	V	W	Base	Piezas por unidad	Embalaje	
	<b>H3</b>	<b>486333000</b>	12	55	PK22s	100	C1
	<b>RPB+</b>						

ECE	Nº de ref.	V	W	Base	Piezas por unidad	Embalaje	
	<b>H4</b>	<b>486773000</b>	12	60/55	P43t-38	100	C1
	<b>RPB+</b>	<b>486774000</b>	12	60/55	P43t-38	10	B1
	<b>486772100</b>	12	60/55	P43t-38	10	S2	

ECE	Nº de ref.	V	W	Base	Piezas por unidad	Embalaje	
	<b>H7</b>	<b>486383000</b>	12	55	PX26d	100	C1
	<b>RPB+</b>	<b>486384000</b>	12	55	PX26d	10	B1
	<b>486382100</b>	12	55	PX26d	10	S2	

ECE	Nº de ref.	V	W	Base	Piezas por unidad	Embalaje	
	<b>HB2</b>	<b>486763000</b>	12	67/60	P43t-38	100	C1
	<b>RPB+</b>						

ECE	Nº de ref.	V	W	Base	Piezas por unidad	Embalaje	
	<b>HB3</b>	<b>486163000</b>	12	60	P20d	100	C1
	<b>RPB+</b>						

ECE	Nº de ref.	V	W	Base	Piezas por unidad	Embalaje	
	<b>HB4</b>	<b>486133000</b>	12	51	P22d	100	C1
	<b>RPB+</b>						

ECE	Nº de ref.	V	W	Base	Piezas por unidad	Embalaje	
	<b>HB5</b>	<b>486293000</b>	12	65/55	PX29t	100	C1
	<b>RPB+</b>						

## Estilo

### RANGE POWER WHITE\*

4500 K de xenón blanco

	Nº de ref.	V	W	Base	Piezas por unidad	Embalaje	
	<b>H1</b>	<b>486412100</b>	12	55	P14,5s	10	S2
	<b>RPW</b>						

	Nº de ref.	V	W	Base	Piezas por unidad	Embalaje	
	<b>H3</b>	<b>486022100</b>	12	55	PK22s	10	S2
	<b>RPW</b>						

	Nº de ref.	V	W	Base	Piezas por unidad	Embalaje	
	<b>H4</b>	<b>486802100</b>	12	60/55	P43t-38	10	S2
	<b>RPW</b>						

	Nº de ref.	V	W	Base	Piezas por unidad	Embalaje	
	<b>H7</b>	<b>486072100</b>	12	55	PX26d	10	S2
	<b>RPW</b>						

	Nº de ref.	V	W	Base	Piezas por unidad	Embalaje	
	<b>HB3</b>	<b>486252100</b>	12	65	P20d	10	S2
	<b>(9005) RPW</b>						

	Nº de ref.	V	W	Base	Piezas por unidad	Embalaje	
	<b>HB4</b>	<b>486262100</b>	12	55	P22d	10	S2
	<b>(9006) RPW</b>						

	Nº de ref.	Contenido	W	Base	Nº de piezas
	<b>H1/W5W RPW kit</b>	<b>H1</b>	85	P14,5s	2
		<b>W5W</b>	5	W2,1x9,5d	2

	Nº de ref.	Contenido	W	Base	Nº de piezas
	<b>H4/W5W RPW kit</b>	<b>H4</b>	100/90	P43t	2
		<b>W5W</b>	5	W2,1x9,5d	2

	Nº de ref.	Contenido	W	Base	Nº de piezas
	<b>H7/W5W RPW kit</b>	<b>H7</b>	85	PX26d	2
		<b>W5W</b>	5	W2,1x9,5d	2

\*Importante En Europa se prohíbe la venta de productos que no lleven el logotipo de certificación ECE y no estén homologados.







**RALLYE\*** *Excelente luminosidad (únicamente para uso fuera de carretera)*

	Nº de ref.	V	W	Base	Piezas por unidad	Embalaje
 <b>H1 Rallye</b>	<b>483503000</b>	12	100	P14,5s	100	C1
	<b>483803000</b>	12	130	P14,5s	100	C1

	Nº de ref.	V	W	Base	Piezas por unidad	Embalaje
 <b>H2 Rallye</b>	<b>484503000</b>	12	100	X511	100	C1

	Nº de ref.	V	W	Base	Piezas por unidad	Embalaje
 <b>H3 Rallye</b>	<b>483513000</b>	12	100	PK22s	100	C1
	<b>483813000</b>	12	130	PK22s	100	C1

	Nº de ref.	V	W	Base	Piezas por unidad	Embalaje
 <b>H4 Rallye P43t</b>	<b>489013000</b>	12	100/90	P43t-38	100	C1
	<b>489014000</b>	12	100/90	P43t-38	10	B1
	<b>489113000</b>	12	100/55	P43t-38	100	C1
	<b>489513000</b>	12	130/100	P43t	100	C1

	Nº de ref.	V	W	Base	Piezas por unidad	Embalaje
 <b>H4 Rallye P45t</b>	<b>488843000</b>	12	60/55	P45t	100	C1
	<b>489043000</b>	12	100/90	P45t-41	100	C1

	Nº de ref.	V	W	Base	Piezas por unidad	Embalaje
 <b>H7 Rallye</b>	<b>483583000</b>	12	80	PX26d	100	C1

	Nº de ref.	V	W	Base	Piezas por unidad	Embalaje
 <b>HB1 Rallye</b>	<b>480343000</b>	12	100/80	P29t	100	C1

	Nº de ref.	V	W	Base	Piezas por unidad	Embalaje
 <b>HB3 Rallye</b>	<b>480253000</b>	12	100	P20d	100	C1

	Nº de ref.	V	W	Base	Piezas por unidad	Embalaje
 <b>HB4 Rallye</b>	<b>480263000</b>	12	70	P22d	100	C1

\*Importante En Europa se prohíbe la venta de productos que no lleven el logotipo de certificación ECE y no estén homologados.

**RALLYE\*** *Excelente luminosidad (únicamente para uso fuera de carretera)*

	Nº de ref.	V	W	Base	Piezas por unidad	Embalaje
 <b>HB5 Rallye</b>	<b>480313000</b>	12	100/80	PX29t	100	C1

\*Importante En Europa se prohíbe la venta de productos que no lleven el logotipo de certificación ECE y no estén homologados.

**Tipos americanos**

Tipo AM.	Nº de ref.	V	W	Base	Piezas por unidad	Embalaje
 <b>9004 (HB1)</b>	<b>480043000</b>	12	65/45	P29t	100	CP

Tipo AM.	Nº de ref.	V	W	Base	Piezas por unidad	Embalaje
 <b>9003 (HB2)</b>	<b>488823000</b>	12	67/60	P43t-38	100	C1

Tipo AM.	Nº de ref.	V	W	Base	Piezas por unidad	Embalaje
 <b>9005 (HB3)</b>	<b>480053000</b>	12	60	P20d	100	C1
	<b>480054000</b>	12	60	P20d	10	B1

Tipo AM.	Nº de ref.	V	W	Base	Piezas por unidad	Embalaje
 <b>9006 (HB4)</b>	<b>480063000</b>	12	51	P22d	100	C1
	<b>480064000</b>	12	51	P22d	10	B1

Tipo AM.	Nº de ref.	V	W	Base	Piezas por unidad	Embalaje
 <b>9007 (HB5)</b>	<b>480073000</b>	12	65/55	PX29t	100	C1

Tipo AM.	Nº de ref.	V	W	Base	Piezas por unidad	Embalaje
 <b>9008 (H13)</b>	<b>480923000</b>	12	60/55	P26,4t	100	C1

Tipo AM.	Nº de ref.	V	W	Base	Piezas por unidad	Embalaje
 <b>9145 (H10)</b>	<b>480953000</b>	12	42	PY20d	100	C1

Tipo AM.	Nº de ref.	V	W	Base	Piezas por unidad	Embalaje
 880	480393000	12.8	27	PG13	100	C1

Tipo AM.	Nº de ref.	V	W	Base	Piezas por unidad	Embalaje
 881	480403000	12.8	27	PGJ13	100	C1

Tipo AM.	Nº de ref.	V	W	Base	Piezas por unidad	Embalaje
 885	480553000	12.8	50	PG13	100	C1

Tipo AM.	Nº de ref.	V	W	Base	Piezas por unidad	Embalaje
 886	480563000	12.8	50	PGJ13	100	C1

Tipo AM.	Nº de ref.	V	W	Base	Piezas por unidad	Embalaje
 889	480453000	12.8	27	PGJ13	100	C1

Tipo AM.	Nº de ref.	V	W	Base	Piezas por unidad	Embalaje
 890	480463000	12.8	27	PG13	100	C1

Tipo AM.	Nº de ref.	V	W	Base	Piezas por unidad	Embalaje
 893	480513000	12.8	37.5	PG13	100	C1

Tipo AM.	Nº de ref.	V	W	Base	Piezas por unidad	Embalaje
 894	480543000	12.8	37.5	PGJ13	100	C1

Tipo AM.	Nº de ref.	V	W	Base	Piezas por unidad	Embalaje
 896	480523000	12.8	37.5	PGJ13	100	C1









# 12V Señalización e iluminación de interior



NARVA ofrece una completa gama de lámparas de señalización de 12V diseñadas para sustituir las lámparas estándar que incluye nuestras lámparas de interior LED, diseñadas para mejorar la visibilidad y la seguridad (consulte la página 33).



## Sustitución







### LÁMPARAS DE SEÑALIZACIÓN

ECE	Nº de ref.	V	W	Base	Piezas por unidad	Embalaje
 (Stop P22)	174113000	12	15	BA15s	200	CP
 (Stop P25) BA15s	175113000	12	18	BA15s	200	CP
 P21W	176353000	12	21	BA15s	200	CP
	176354000	12	21	BA15s	10	B2
	176403000	12	21	BAU15s	200	CP
 PY21W Amber	176383000	12	21	BAU15s	200	CP
	176384000	12	21	BAU15s	10	B2
 P21/4W	178813000	12	21/4	BAZ15d	200	CP
	178814000	12	21/4	BAZ15d	10	B2



ECE	Nº de ref.	V	W	Base	Piezas por unidad	Embalaje
 P21/5W	179163000	12	21/5	BAY15d	200	CP
	179164000	12	21/5	BAY15d	10	B2
 (Stop P25) BA15d	179183000	12	21/5	BA15d	200	CP
 R5W BA15s	171713000	12	5	BA15s	200	CP
	171714000	12	5	BA15s	10	B2
 R5W BA15d	171723000	12	5	BA15d	200	CP
 R10W	173113000	12	10	BA15s	200	CP
	173114000	12	10	BA15s	10	B2
 RY10W	173173000	12	10	BAU15s	200	CP
 170513000	170513000	12	2	BA7s	200	CP
 170533000	170533000	12	2	BA9s	200	CP
 T4W	171313000	12	4	BA9s	200	CP











## LÁMPARAS HALÓGENAS EN MINIATURA

ECE	Nº de ref.	V	W	Base	Piezas por unidad	Embalaje
 (H5W)	178303000	12	5	BA9s	200	CP
 H6W	681613000	12	6	BAX9s	200	CP
 H6W LL	681623000	12	6	BAX9s	200	CP
 (H10W)	178333000	12	10	BA9s	200	CP
 (H20W)	178353000	12	20	BA9s	200	CP
 H21W	681913000	12	21	BAY9s	200	CP
 (W2,2W)	170593000	12	2.2	W2,1x9,5d200	CP	









## LÁMPARAS INDICADORAS DE BASE EN CUÑA

ECE	Nº de ref.	V	W	Base	Piezas por unidad	Embalaje
 (W1,2W) Frosted	170323000	12	1.2	W2x4,6d	200	CP
 (W1,2W)	170373000	12	1.2	W2x4,6d	200	CP

ECE	Nº de ref.	V	W	Base	Piezas por unidad	Embalaje
 W2,3W	170733000	12	2.3	W2x4,6d	200	CP
 W3W	170973000	12	3	W2,1x9,5d200	CP	
 W5W	171773000 171774000	12 12	5 5	W2,1x9,5d200 W2,1x9,5d	CP 10	CP B2
 WY5W	171693000	12	5	W2,1x9,5d200	CP	
 W16W	176313000	12	16	W2,1x9,5d200	CP	
 W21W	176323000	12	21	W3x16d	200	CP
 WY21W	176293000	12	21	WX3x16d	200	CP
 W21/5W	179193000	12	21/5	W3x16q	200	CP



## LÁMPARAS FESTOON

ECE	Nº de ref.	V	W	Base	Piezas por unidad	Embalaje
 T8.2x30	170943000	12	3	SV7,5	200	CP
 C5W	171253000	12	5	SV8,5	200	CP
	171254000	12	5	SV8,5	10	B2
 T10.5x43	171753000	12	5	SV8,5	200	CP
 T10.5x43	173143000	12	10	SV8,5	200	CP
 T10.5x30	173153000	12	10	SV8,5	200	CP
 T10.5x38	173163000	12	10	SV8,5	200	CP
 T15x43	175123000	12	18	SV8,5	200	CP
 C21W	176343000	12	21	SV8,5	200	CP

## LÁMPARAS CON BASE PLÁSTICA (BAX)



ECE	Nº de ref.	V	W	Base	Piezas por unidad	Embalaje
 170063000	170063000	12	0.4	Bax 8,5d blue violet	200	CP
 170193000	170193000	12	1	Bax 8,5d orange	200	CP
 170273000	170273000	12	1.2	Bax 8,4d light blue	200	CP
 170283000	170283000	12	1.2	Bax 8,4d black	200	CP
 170293000	170293000	12	1.2	Bax 8,5d blue	200	CP
 170353000	170353000	12	1.2	Bax 8,5d black	200	CP
 170363000	170363000	12	1.2	Bax 8,3d black	200	CP
 170463000	170463000	12	1.1	Bax 8,4d orange	200	CP
 170473000	170473000	12	1.3	Bax 8,4d olive green	200	CP

ECE	Nº de ref.	V	W	Base	Piezas por unidad	Embalaje
	<b>17048</b> 3000	12	1.5	Bax 8,4d beige	200	CP
	<b>17049</b> 3000	12	1.5	Bax 8,5d beige	200	CP
	<b>17050</b> 3000	12	1.5	Bax 8,5d yellow	200	CP
	<b>17052</b> 3000	12	2	Bax 8,5d light green	200	CP
	<b>17054</b> 3000	12	2	Bax 8,4d light green	200	CP
	<b>17057</b> 3000	12	2	Bax 8,5d green	200	CP
	<b>17058</b> 3000	12	2	Bax 8,3d blue	200	CP
	<b>17060</b> 3000	12	1.8	Bax 8,4d beige	200	CP
	<b>17163</b> 3000	12	5	Bax 10d black	100	C1



## Estilo

### RANGE POWER BLUE+

Hasta un 50% más visibilidad, elegante blanco

ECE	Nº de ref.	V	W	Base	Piezas por unidad	Embalaje
	<b>T4W RPB+</b> <b>17137</b> 3000	12	4	BA9s	200	CP
	<b>W5W RPB+</b> <b>17189</b> 3000	12	5	W2,1x9,5d200	CP	
	<b>H6W RPB+</b> <b>68163</b> 3000	12	6	BAX9s	200	CP

## Tipos americanos

Tipo AM.	Nº de ref.	V	W	Base	Piezas por unidad	Embalaje
	<b>3156</b> <b>17941</b> 3000	12.8	32CP	W2,5x16d	200	CP
	<b>3157</b> <b>17945</b> 3000	12.8/14	32/3CP	W2,5x16q	200	CP
	<b>3157 NA</b> <b>17948</b> 3000	12.8/14	24/2.2CP	W2,5x16q	200	CP



# ¿Qué tipo de lámpara de 12V necesita?



Luces de carretera - luz de cruce - Luces de marcha diurnas



Iluminación interior



Luces de salpicadero



Luces intermitentes laterales



Luces intermitentes delanteras



Luces delanteras de niebla



Luces delanteras de posición



Tercera luz de frenado



Luz del maletero



Luces de marcha atrás



Luces intermitentes traseras



Luz de guantera



Luces traseras de posición



Lámpara de placa de matriculación



Luces traseras de niebla



Luces de frenado





# 12V Kits de repuestos y herramientas de ventas

En muchos países europeos están recomendados los kits de repuestos y en países como Francia son obligatorios. Nuestros kits de repuesto proporcionan a los conductores la seguridad que necesitan mientras viajan por carretera.



## KITS DE REPUESTOS

ECE	Nº de ref.	Contenido	W	Base	Nº de piezas
	<b>980043010</b>	<b>H4</b>	60/55	P43t	1
		<b>P21W</b>	21	BA15s	1
		<b>R5W</b>	5	BA15s	1
		<b>W5W</b>	5	W2,1x9,5d	1
		<b>Flat fuse</b>			2
		Cantidad de embalaje			20

ECE	Nº de ref.	Contenido	W	Base	Nº de piezas
	<b>984003010</b>	<b>H4</b>	60/55	P43t	1
		<b>P21/5W</b>	21/5	BAY15d	1
		<b>P21W</b>	21	BA15s	1
		<b>R5W</b>	5	BA15s	1
		<b>C5W</b>	5	SV8,5	1
		<b>W5W</b>	5	W2,1x9,5d	1
		<b>Flat fuse</b>			4
		Cantidad de embalaje			20

ECE	Nº de ref.	Contenido	W	Base	Nº de piezas
	<b>984353010</b>	<b>H7</b>	55	PX26d	1
		<b>H1</b>	55	P14,5s	1
		<b>P21/5W</b>	21/5	BAY15d	1
		<b>P21W</b>	21	BA15s	1
		<b>PY21W</b>	21	BAU15s	1
		<b>C5W</b>	5	SV8,5	1
		<b>W5W</b>	5	W2,1x9,5d	1
		<b>Flat fuse</b>			4
		Cantidad de embalaje			20

## KITS RANGE POWER WHITE

Nº de ref.	Contenido	W	Base	Nº de piezas	
	<b>980142100</b>	<b>H1</b>	85	P14,5s	2
		<b>W5W</b>	5	W2,1x9,5d	2
	Cantidad de embalaje				10

Nº de ref.	Contenido	W	Base	Nº de piezas	
	<b>980152100</b>	<b>H4</b>	100/90	P43t	2
		<b>W5W</b>	5	W2,1x9,5d	2
	Cantidad de embalaje				10

Nº de ref.	Contenido	W	Base	Nº de piezas	
	<b>980162100</b>	<b>H7</b>	85	PX26d	2
		<b>W5W</b>	5	W2,1x9,5d	2
	Cantidad de embalaje				10

**\*Importante** En Europa se prohíbe la venta de productos que no lleven el logotipo de certificación ECE y no estén homologados.





## CAJA BAX

ECE	Nº de ref.	Contenido	W	Base	Nº de piezas
<b>Conjunto Bax 12V</b>	<b>987503000</b>	<b>Bax</b>	1.2	Bax 8,3d black	10
		<b>Bax</b>	2	Bax 8,3d blue	10
		<b>Bax</b>	1.2	Bax 8,5d black	10
		<b>Bax</b>	2	Bax 8,5d green	10
		<b>Bax</b>	1.5	Bax 8,5d blue violet	10
		<b>Bax</b>	0.4	Bax 8,5d beige	10
		<b>Bax</b>	1	Bax 8,5d blue violet	10
		<b>Bax</b>	1.2	Bax 8,5d blue	10
		<b>Bax</b>	2	Bax 8,5d light green	10
		<b>Bax</b>	1.1	Bax 8,4d orange	10
		<b>Bax</b>	1.2	Bax 8,4d black	10
		<b>Bax</b>	1.3	Bax 8,4d olive green	10
		<b>Bax</b>	1.5	Bax 8,4d beige	10
		<b>Bax</b>	1.8	Bax 8,4d beige	10
		<b>Bax</b>	2	Bax 8,4d light green	10
Cantidad de embalaje					5

## HERRAMIENTAS DE VENTAS



### Expositor de mostrador

GOC: 80277000

Se entrega con

- 20x H7 estándar
- 10x H4 estándar



### Expositor para suelo

GOC: 90267000

Expositor para suelo de cartón resistente se entrega vacío.

- 12 ganchos
- Cabecera intercambiable



### Dispensador para pared

GOC (vacío): 80173000

GOC (lleno): 80223000

Se entrega vacío o lleno de lámparas (ver composición a continuación).

- Carcasa metálica resistente
- Tamaño compacto: 37 x 17,6 x 59,5 cm
- Se puede cerrar con llave

Se entrega con

- |              |            |                     |
|--------------|------------|---------------------|
| ■ 10x H1     | ■ 30x P21W | ■ 20x Fest T10,5x43 |
| ■ 10x H3     | ■ 30x R5W  | ■ 20x W1,2W         |
| ■ 30x H4     | ■ 30x R10W | ■ 20x W3W           |
| ■ 50x H7     | ■ 30x T4W  | ■ 30x W5W           |
| ■ 30x P21/5W | ■ 30x C5W  |                     |

# LED



**LED**

# Range Power LED

Transforme su automóvil de estándar a elegante en un solo movimiento con las nuevas y maravillosas bombillas LED NARVA Range Power. Con una luz blanca nítida y colores brillantes, no solo será atractivo, las luces brillantes lo ayudarán a ver más y reaccionar más rápido.

## LÁMPARAS DELANTERAS

Ilumine la carretera con faros blancos brillantes, lo que garantiza una gran visibilidad y una apariencia increíble. Debido a su tamaño compacto y diseño de "gire y ajuste", estas lámparas son una de las más fáciles de instalar. Con una resistencia térmica superior, las luces están protegidas del daño por calor, lo que las hace más duraderas.

El diseño óptico avanzado garantiza una conducción segura sin deslumbrar a los conductores en sentido contrario.



Halógena estándar



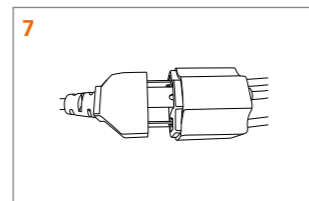
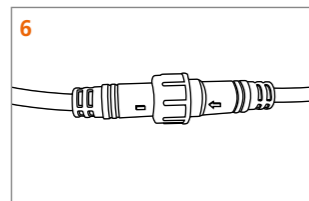
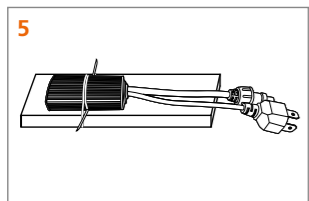
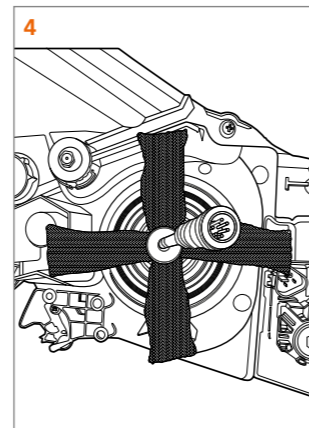
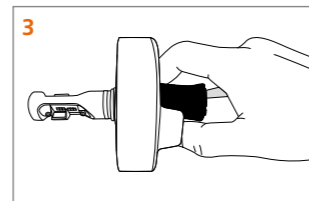
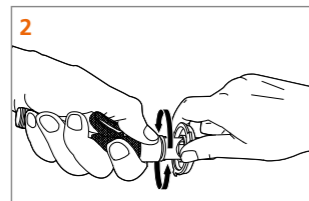
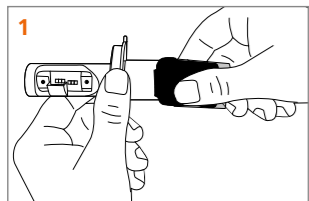

Range Power LED





 Es su propia responsabilidad usar las luces LED retrofit conforme con los requisitos legales aplicables.

ECE	Ref. No	V	W	Base	Pieces/PU	Packaging
 LED-HL [≈H4]	<b>180043000</b>	12	16	P43t-38	6	X2

ECE	Ref. No	V	W	Base	Pieces/PU	Packaging
 LED-HL [≈H7]	<b>180053000</b>	12	16	PX26d	6	X2

ECE	Ref. No	V	W	Base	Pieces/PU	Packaging
 LED-FOG [≈H8/H11/H16]	<b>180133000</b>	12	16	PGJ19-1/2/3	6	X2

ECE	Ref. No	V	W	Base	Pieces/PU	Packaging
 LED-HL [≈HB3/HB4]	<b>180143000</b>	12	16	P20d/P22d	6	X2

ECE	Ref. No	V	W	Base	Pieces/PU	Packaging
 LED-HL [≈HIR2]	<b>180153000</b>	12	16	PX22D	6	X2





ECE	Ref. No	V	W	Base	Pieces/PU	Packaging
 LED-HL [≈H11]	<b>180163000</b>	12	16	PGJ19-2	6	X2



## SEÑALIZACIÓN E ILUMINACIÓN DE INTERIOR

Las NARVA Range Power LED ofrecen una iluminación de señalización e interior nítida y brillante. Además de quedar más atractivo, ahora cada vez que maniobre en la carretera, otros conductores verán rápida y claramente lo que está haciendo, para que usted y ellos estén más seguros. Para obtener productos de alta calidad que garanticen un rendimiento continuo y actualizar su estilo, elija NARVA Range Power LED.

¡Transforme su coche, elija NARVA Range Power LED!

ECE	Ref. No	V	W	Base	Piezas/PU	Packaging
 LED-T10 [≈W5W]	180034000	12	0.60	W2,1x9,5d	10	B2
 LED-FEST [38mm]	180064000	12	0.60	SV8,5	10	B1
 LED-RED [P21W]	180074000	12	2.70	BA15s	10	B2
 LED-RED [P21/5W]	180084000	12	2.70	BAY15d	10	B2
 LED-T20-RED [W21/5W]	180094000	12	2.70	BAU15s	10	B2

## ¿Qué LED retrofit necesita?

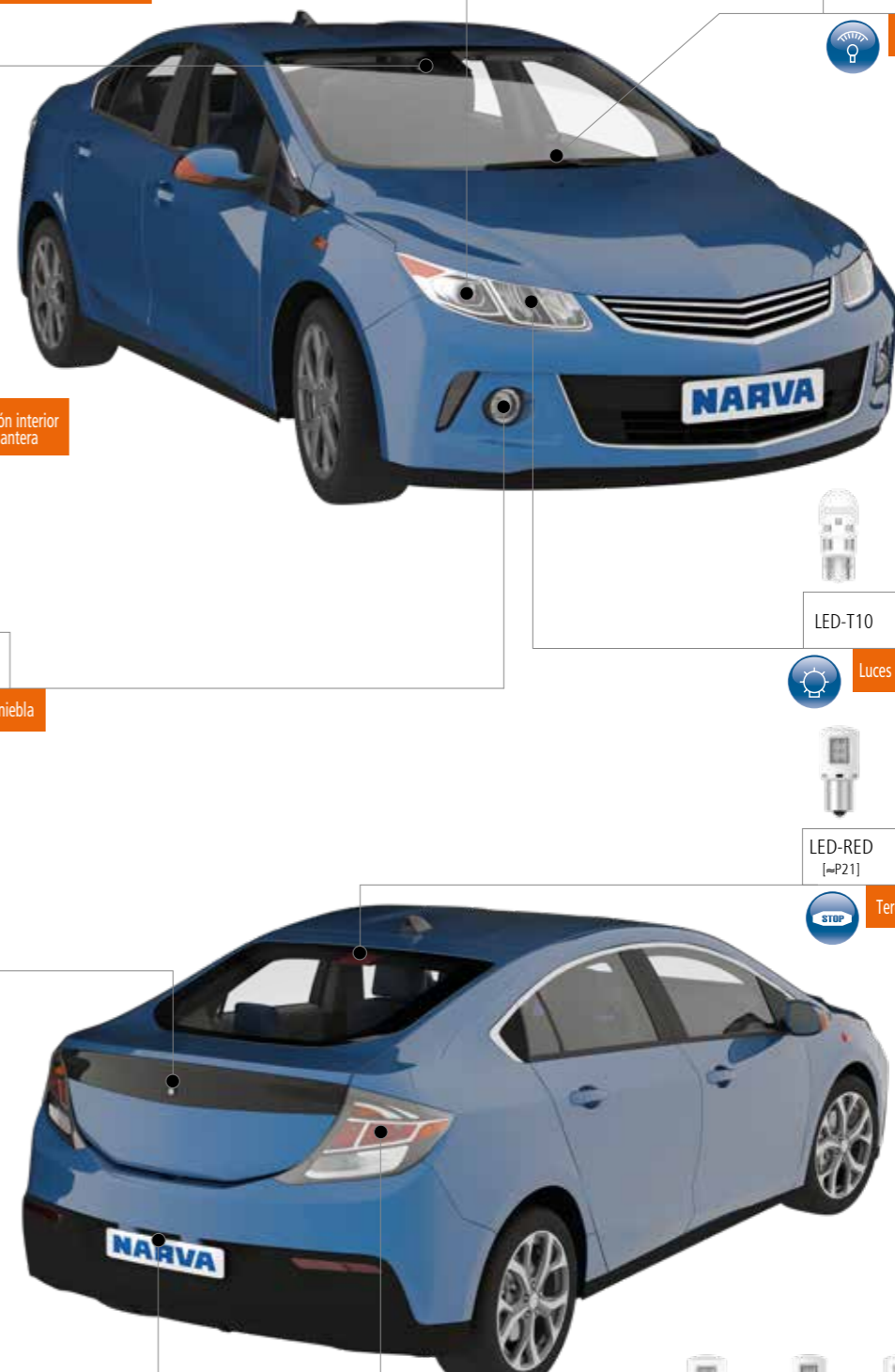

**Luces de carretera - Luz de cruce**  
LED-HL [≈H4] LED-HL [≈H7] LED-HL [≈HB3/HB4] LED-HL [≈HIR2] LED-HL [≈H11]

**Luces de salpicadero**  
LED-T10

**Iluminación interior Luz de guantera**  
LED-T10 LED-FEST 38mm

**Luces delanteras de niebla**  
LED-FOG [≈H8/H11/H16] LED-HL [≈H11]

**Luces delanteras de posición**  
LED-T10

**Tercera luz de frenado**  
LED-RED [≈P21]

**Luz del maletero**  
LED-T10 LED-FEST 38mm

**Lámpara de placa de matriculación**  
LED-T10 LED-FEST 38mm

**Luces de frenado - Luces traseras de posición**  
LED-T20-RED [≈W21/5] LED-RED [≈P21] LED-RED [≈P21/5]

 Es su propia responsabilidad usar las luces LED retrofit conforme con los requisitos legales aplicables.



# Soluciones xenón



La gama xenón de NARVA produce un haz de luz blanca brillante y precisa, y ofrece una mayor visibilidad para una mayor seguridad.

La tecnología xenón de NARVA implica una mayor duración y hasta un 3 veces más visibilidad en comparación con una lámpara estándar. Con un cristal especial de cuarzo que bloquea los rayos UV, esta solución de iluminación proporciona la máxima seguridad permitiendo a los conductores ver aún más lejos.



## INFORMACIÓN SOBRE SISTEMAS DE ILUMINACIÓN DE XENÓN

Una lámpara Xenon HID (Descarga de alta intensidad)

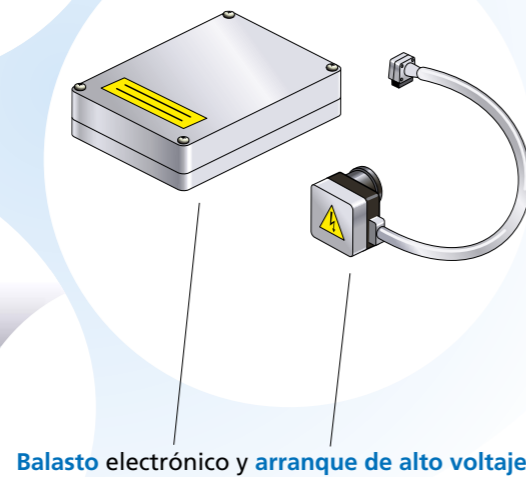

Balasto electrónico y arranque de alto voltaje

### Principales ventajas

- Proyección de luz brillante y potente en la carretera
- Intensidad y color de la luz próximas a la luz diurna
- Duración extralarga
- Bajo consumo energético

Complejo sistema óptico con control de nivel automático y sistema de lavado electrónico

## XENÓN HID LÁMPARAS DELANTERAS

ECE	Nº de ref.	V	W	Base	Piezas por unidad	Embalaje
D1S	840103000	85	35	PK32d-2	2	C1
D1R	840113000	85	35	PK32d-3	2	C1
D2S	840023000	85	35	P32d-2	2	C1
D2R	840063000	85	35	P32d-3	2	C1
D3S	840323000	42	35	PK32d-5	2	C1
D4S	840423000	42	35	P32d-5	2	C1





# 24V Soluciones halógenas Lámparas delanteras

Nuestras gamas de iluminación **Standard y Heavy Duty de 24V**

son robustas y fiables para los camiones actuales y otros vehículos pesados.

Las Lámparas delanteras para camión de NARVA ofrecen resistencia a la vibración y calidad superior. Compruebe nuestras lámparas Standard o nuestra gama





Heavy Duty cuando precise de mayor solidez y durabilidad



## Sustitución

### STANDARD

*Buena relación calidad-precio*

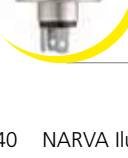
ECE	Nº de ref.	V	W	Base	Piezas por unidad	Embalaje	
	<b>H1</b>	<b>487023000</b>	24	70	P14,5s	100	C1
		<b>487024000</b>	24	70	P14,5s	10	B1
	<b>H2</b>	<b>487203000</b>	24	70	X511	100	C1
	<b>H3</b>	<b>487003000</b>	24	70	PK22s	100	C1
	<b>H4</b>	<b>488923000</b>	24	75/70	P43t	100	C1
		<b>488924000</b>	24	75/70	P43t-38	10	B1
	<b>H7</b>	<b>487283000</b>	24	70	PX26d	100	C1
		<b>487284000</b>	24	70	PX26d	10	B1
	<b>R2 Halogen</b>	<b>481323000</b>	24	55/50	P45t-41	100	C1







ECE	Nº de ref.	V	W	Base	Piezas por unidad	Embalaje
<b>R2</b>	<b>493213000</b>	24	55/50	P45t	100	C1

## Durabilidad

### HEAVY DUTY





*Resiste todas las vibraciones*

ECE	Nº de ref.	V	W	Base	Piezas por unidad	Embalaje	
	<b>H1 HD</b>	<b>487083000</b>	24	70	P14,5s	100	C1
	<b>H3 HD</b>	<b>487093000</b>	24	70	PK22s	100	C1
	<b>H4 HD</b>	<b>488983000</b>	24	75/70	P43t-38	100	C1
	<b>H7 HD</b>	<b>487293000</b>	24	70	PX26d	100	C1

## Estilo

### RALLYE\*

*Excelente luminosidad (únicamente para uso fuera de carretera)*

ECE	Nº de ref.	V	W	Base	Piezas por unidad	Embalaje	
	<b>H1 Rallye</b>	<b>487503000</b>	24	100	P14,5s	100	C1
	<b>H3 Rallye</b>	<b>487513000</b>	24	100	PK22s	100	C1
	<b>H4 Rallye P43t</b>	<b>489913000</b>	24	100/90	P43t-38	100	C1
	<b>H4 Rallye P45t</b>	<b>488943000</b>	24	75/70	P45t-41	100	C1
		<b>489943000</b>	24	100/90	P45t-41	100	C1

\*Importante En Europa se prohíbe la venta de productos que no lleven el logotipo de certificación ECE y no estén homologados.



# 24V Señalización e iluminación de interior

NARVA ofrece una completa gama de iluminación de interior y señalización para camiones actuales y otros vehículos pesados. Diseñada para la solidez y la durabilidad, descubra nuestra iluminación de interior y señalización de 24V hoy mismo.



## Sustitución

### LÁMPARAS DE SEÑALIZACIÓN

ECE	Nº de ref.	V	W	Base	Piezas por unidad	Embalaje
	<b>179273000</b>	24	21/5	BA15d	200	CP

ECE	Nº de ref.	V	W	Base	Piezas por unidad	Embalaje
<b>P21W</b>	<b>176433000</b>	24	21	BA15s	200	CP
	<b>176434000</b>	24	21	BA15s	10	B2

ECE	Nº de ref.	V	W	Base	Piezas por unidad	Embalaje
<b>P21/4W</b>	<b>178823000</b>	24	21/4	BAZ15d	200	CP

ECE	Nº de ref.	V	W	Base	Piezas por unidad	Embalaje
<b>P21/5W</b>	<b>179253000</b>	24	21/5	BAY15d	200	CP

ECE	Nº de ref.	V	W	Base	Piezas por unidad	Embalaje
<b>Stop P22</b>	<b>174213000</b>	24	15	BA15s	200	CP

ECE	Nº de ref.	V	W	Base	Piezas por unidad	Embalaje
<b>R5W BA15s</b>	<b>171813000</b>	24	5	BA15s	200	CP
	<b>171814000</b>	24	5	BA15s	10	B2

ECE	Nº de ref.	V	W	Base	Piezas por unidad	Embalaje
<b>R5W</b>	<b>171823000</b>	24	5	BA15d	200	CP

ECE	Nº de ref.	V	W	Base	Piezas por unidad	Embalaje
<b>(R10W)</b>	<b>173223000</b>	24	10	BA15d	200	CP

ECE	Nº de ref.	V	W	Base	Piezas por unidad	Embalaje
	<b>170613000</b>	24	3	BA7s	200	CP

ECE	Nº de ref.	V	W	Base	Piezas por unidad	Embalaje
	<b>170633000</b>	24	2	BA9s	200	CP

ECE	Nº de ref.	V	W	Base	Piezas por unidad	Embalaje
<b>T4W</b>	<b>171413000</b>	24	4	BA9s	200	CP

### LÁMPARAS HALÓGENAS EN MINIATURA

ECE	Nº de ref.	V	W	Base	Piezas por unidad	Embalaje
<b>H21W</b>	<b>681963000</b>	24	21	BAY9s	200	CP

## LÁMPARAS INDICADORAS DE BASE EN CUÑA

ECE	Nº de ref.	V	W	Base	Piezas por unidad	Embalaje
 W1,2W	170403000	24	1.2	W2x4,6d	200	CP

ECE	Nº de ref.	V	W	Base	Piezas por unidad	Embalaje
 W3W	171093000	24	3	W2,1x9,5d200	CP	

ECE	Nº de ref.	V	W	Base	Piezas por unidad	Embalaje
 W5W	171973000	24	5	W2,1x9,5d200	CP	

## LÁMPARAS FESTOON

ECE	Nº de ref.	V	W	Base	Piezas por unidad	Embalaje
 T8.2x30	171043000	24	3	SV7,5	200	CP

ECE	Nº de ref.	V	W	Base	Piezas por unidad	Embalaje
 C5W	171363000	24	5	SV8,5	200	CP

ECE	Nº de ref.	V	W	Base	Piezas por unidad	Embalaje
 T10.5x43	171853000	24	5	SV8,5	200	CP

ECE	Nº de ref.	V	W	Base	Piezas por unidad	Embalaje
 T10.5x43	173273000	24	10	SV8,5	200	CP

ECE	Nº de ref.	V	W	Base	Piezas por unidad	Embalaje
 T15x43	175223000	24	18	SV8,5	200	CP

## LÁMPARAS CON BASE PLÁSTICA (BAX)

ECE	Nº de ref.	V	W	Base	Piezas por unidad	Embalaje
 170223000	170223000	24	1.2	EBS-R4 yellow	200	CP

ECE	Nº de ref.	V	W	Base	Piezas por unidad	Embalaje
 170383000	170383000	24	1.2	Bax 8,3d grey	200	CP

ECE	Nº de ref.	V	W	Base	Piezas por unidad	Embalaje
 170393000	170393000	24	1.2	Bax 8,5d grey	200	CP

ECE	Nº de ref.	V	W	Base	Piezas por unidad	Embalaje
 170673000	170673000	24	1.8	Bax 8,4d blue	200	CP

ECE	Nº de ref.	V	W	Base	Piezas por unidad	Embalaje
 170763000	170763000	24	1.2	Bax 8,5d brown	200	CP

ECE	Nº de ref.	V	W	Base	Piezas por unidad	Embalaje
 170813000	170813000	24	1.4	REF29 white	200	CP

ECE	Nº de ref.	V	W	Base	Piezas por unidad	Embalaje
 170823000	170823000	24	1.4	Bax 8,4d light green	200	CP

ECE	Nº de ref.	V	W	Base	Piezas por unidad	Embalaje
 171023000	171023000	24	1.2	EBS-R6 brown	200	CP





ECE	Nº de ref.	V	W	Base	Piezas por unidad	Embalaje
 171033000	171033000	24	1.2	EBS-R white 1,25 mm FR	200	CP

ECE	Nº de ref.	V	W	Base	Piezas por unidad	Embalaje
 170723000	170723000	24	1.2	EBS-R white frosted	200	CP

# Durabilidad

## HEAVY DUTY

Resiste todas las vibraciones

ECE	Nº de ref.	V	W	Base	Piezas por unidad	Embalaje	
	<b>P21W HD</b>	<b>17644</b> 3000	24	21	BA15s	200	CP
	<b>PY21W HD</b>	<b>17649</b> 3000	24	21	BAU15s	200	CP
	<b>T4W HD</b>	<b>17143</b> 3000	24	4	BA9s	200	CP
	<b>R5W HD</b>	<b>17186</b> 3000	24	5	BA15s	200	CP
	<b>R10W HD</b>	<b>17328</b> 3000	24	10	BA15s	200	CP

# ¿Qué tipo de lámpara de 24V necesita?







# 24V Kits de repuestos y herramientas de ventas

En muchos países europeos están recomendados los kits de repuestos y en países como Francia son obligatorios. NARVA ha diseñado sus kits de repuestos para que los conductores puedan cambiar las lámparas fundidas de un modo rápido y fácil.



## KITS DE REPUESTOS

ECE	Nº de ref.	Contenido	W	Base	Nº de piezas
Kit de repuestos H4	986143010	H4	75/70	P43t	2
		P21W	21	BA15s	6
		R10W	10	BA15s	2
		C10W	10	SV8,5	2
		W5W	5	W2,1x9,5d	2
		Flat fuse			8
		Cantidad de embalaje			

ECE	Nº de ref.	Contenido	W	Base	Nº de piezas
Kit de repuestos H7	986303010	H7	70	PX26d	2
		P21W	21	BA15s	4
		PY21W	21	BA15s	2
		R10W	10	BA15s	2
		C10W	10	SV8,5	2
		W5W	5	W2,1x9,5d	2
		Flat fuse			3
Cantidad de embalaje				20	

## HERRAMIENTAS DE VENTAS



### Dispensador para pared

GOC (vacío): 80173000

GOC (lleno): 90287000

Se entrega lleno de lámparas (ver composición a continuación).

- Carcasa metálica resistente
- Tamaño compacto: 37 x 17,6 x 59,5 cm
- Se puede cerrar con llave

Se entrega con

- 15x H1
- 15x H3
- 10x H4
- 20x H7
- 10x P21W
- 10x PY21W HD
- 10x R5W
- 10x R10W
- 10x T4W
- 10x W3W
- 10x W5W
- 10x W12W
- 10x C5W



### Expositor de mostrador

GOC: 80287000

Se entrega con

- 20x H7 estándar
- 10x H4 estándar

# Iluminación para vehículos de dos ruedas

## Lámparas delanteras

NARVA ofrece una iluminación para motocicletas perfecta para las condiciones de tráfico exigentes de hoy en día. Nuestras lámparas para motocicletas ofrecen la visibilidad y la seguridad que los motoristas necesitan.



ECE	Nº de ref.	V	W	Base	Piezas por unidad	Embalaje
S3	490143000	12	15	P26s	200	CP
	490043000	6	15	P26s	200	CP

ECE	Nº de ref.	V	W	Base	Piezas por unidad	Embalaje
(M5) P15d-25-1	420073000	12	35/35	P15d-25-1	100	C1
	420053000	12	25/25	P15d-25-1	100	C1
	420013000	12	18/18	P15d-25-1	100	C1

ECE	Nº de ref.	V	W	Base	Piezas por unidad	Embalaje
(M5) P15d-25-3	420173000	12	35/35	P15d-25-3	100	C1
	420153000	12	25/25	P15d-25-3	100	C1

ECE	Nº de ref.	V	W	Base	Piezas por unidad	Embalaje
(M5) BA20d	420273000	12	35/35	BA20d	100	C1
	420253000	12	25/25	BA20d	100	C1

## Sustitución

### STANDARD Buena relación calidad-precio

ECE	Nº de ref.	V	W	Base	Piezas por unidad	Embalaje
H51	482203000	12	35/35	PX43t	100	C1

ECE	Nº de ref.	V	W	Base	Piezas por unidad	Embalaje
H3	483013000	6	55	PK22s	100	C1

ECE	Nº de ref.	V	W	Base	Piezas por unidad	Embalaje
H4 Rallye	482223000	12	35/35	P43t-38	100	C1

ECE	Nº de ref.	V	W	Base	Piezas por unidad	Embalaje
F2	490723000	12	35	BA20s	200	C1

# ¿Qué tipo de lámpara para vehículos de dos ruedas necesita?

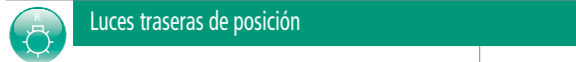
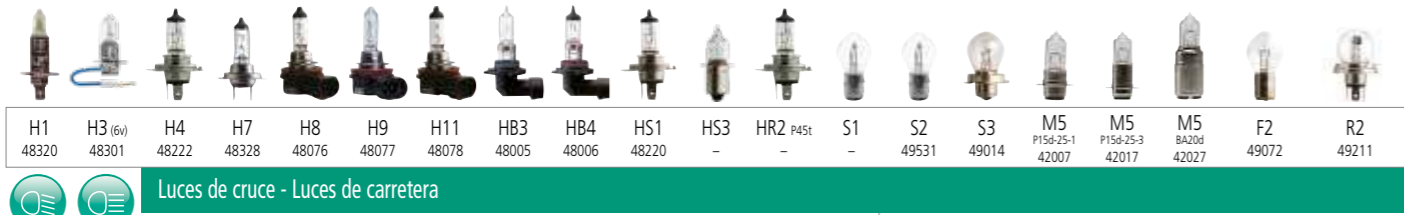

## Ilustraciones técnicas

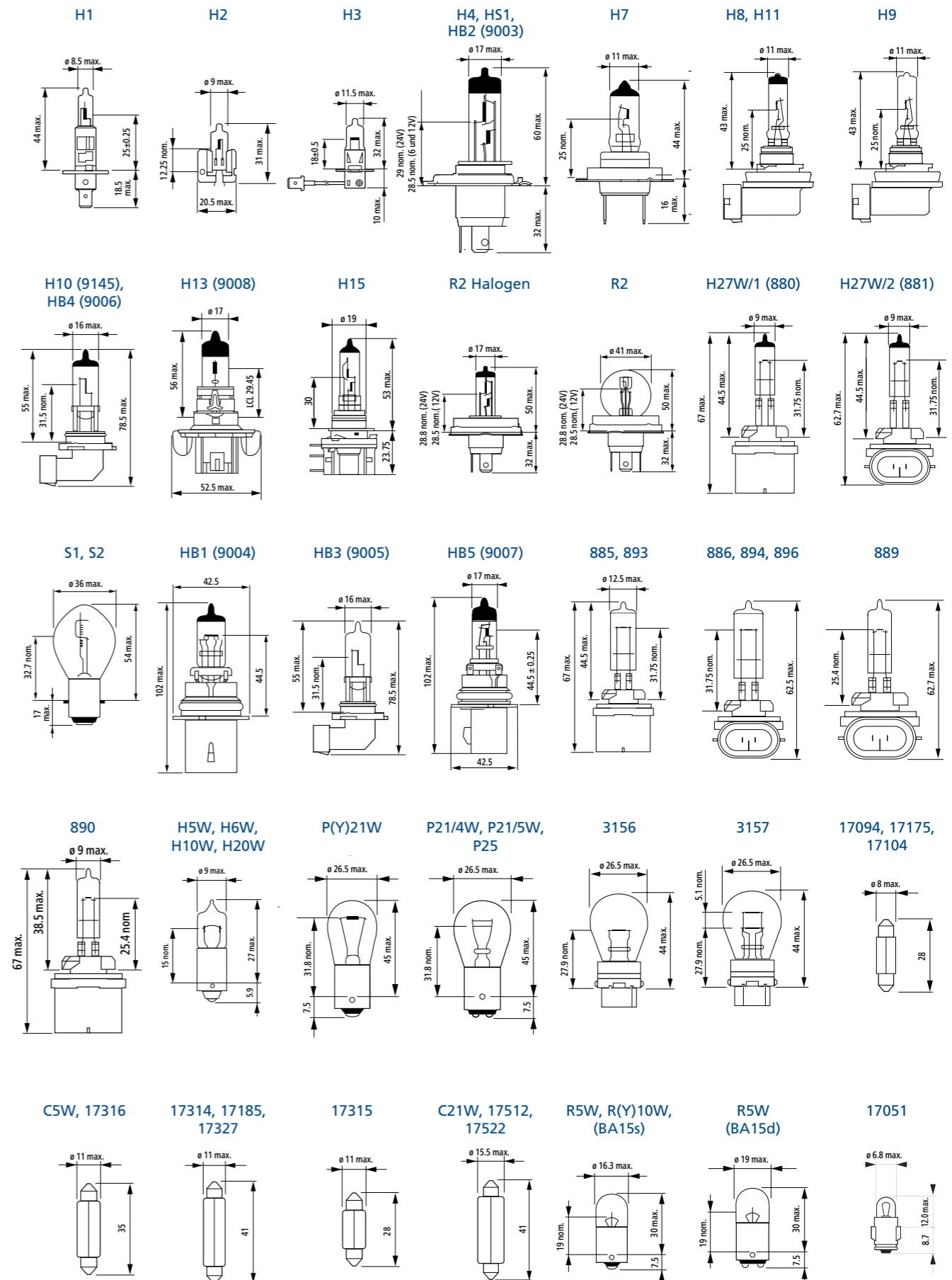

# Casquillos (IEC 60061-1)

17053, 17063

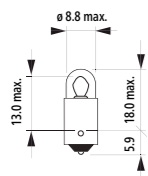

T4W

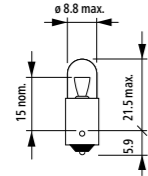

W1,2W,  
W2,3W

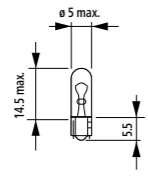

W2,2W, W3W,  
W(Y)5W

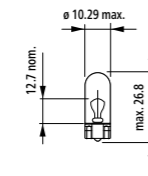

W16W

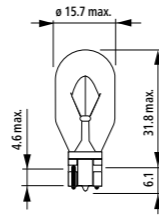

W(Y)21W

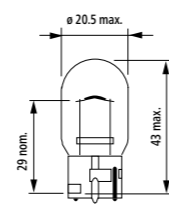

W21/5W

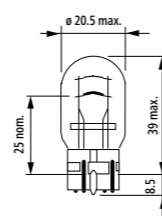

H21W

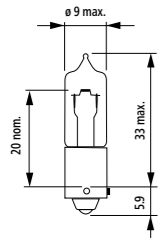

70761

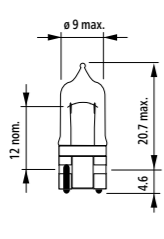

Bax 8,3d

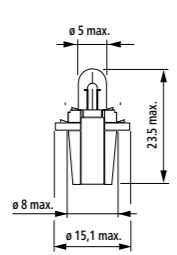

Bax 8,4d

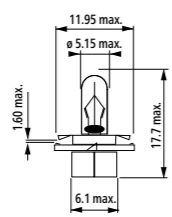

Bax 8,5d

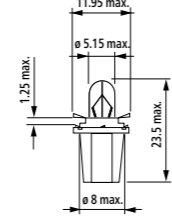

Bax 10d

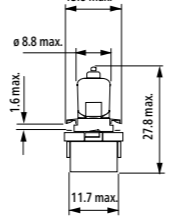

Bax EBS-R

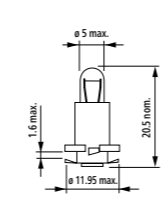

Bax REF29

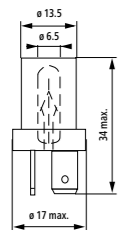

WB T10 LED

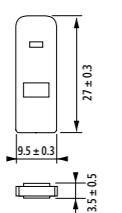

D1S, D3S

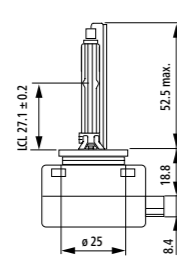

D1R

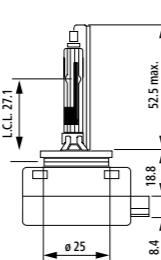

D2S, D4S

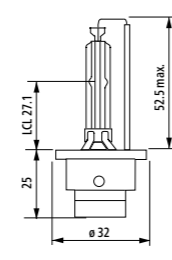

D2R

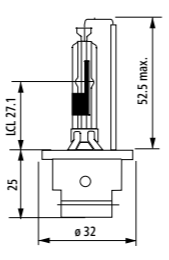

F

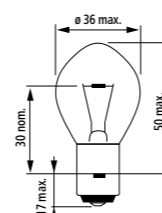

S3

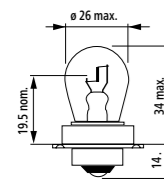

M5  
(P15d-25-1)

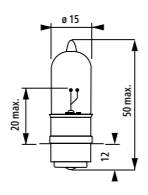

M5  
(P15d-25-3)

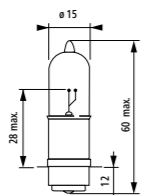

M5  
(BA20d)

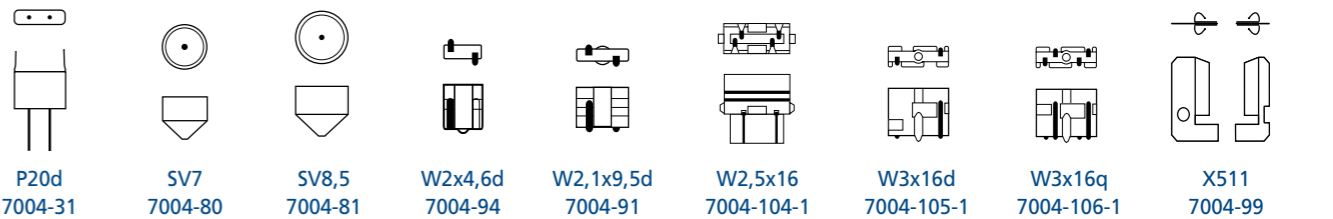
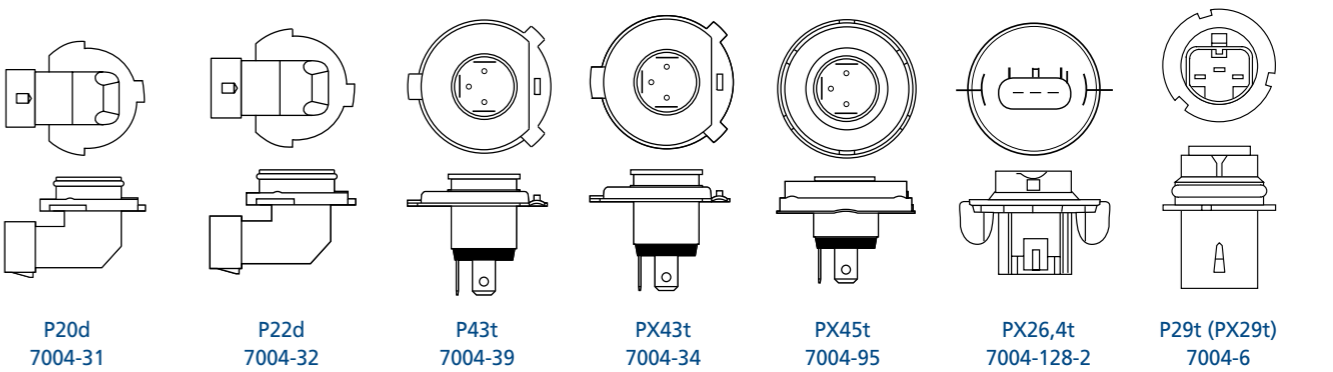
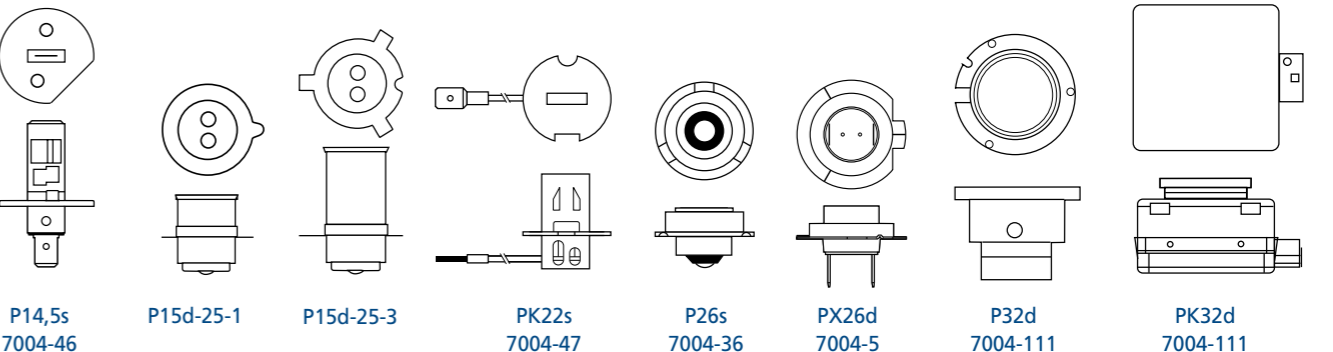
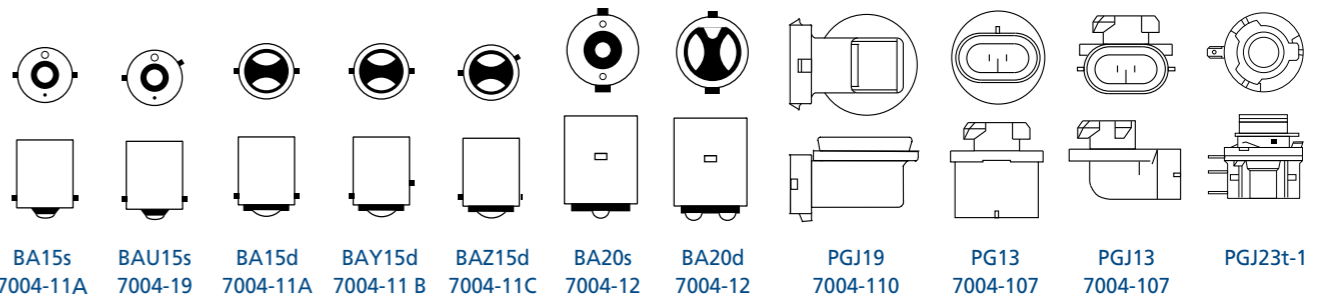
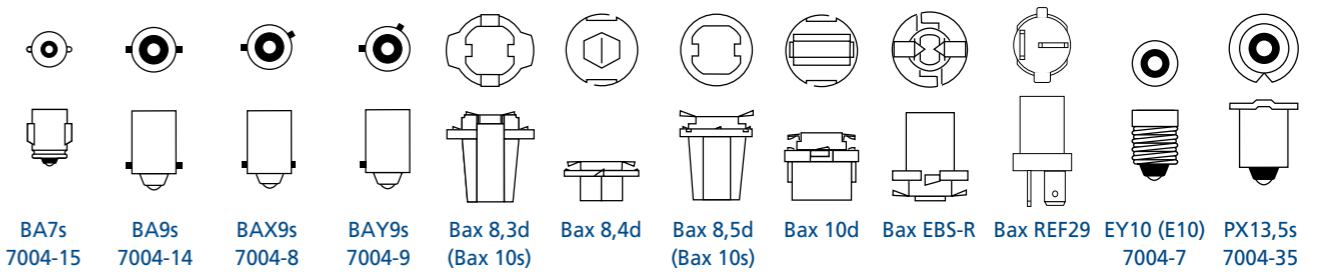
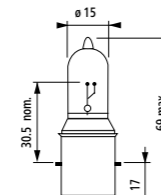

# Embalaje

## Nuevo embalaje especial Narva

Nuestro nuevo embalaje puede utilizarse para paquetes dobles especiales o para kits de repuesto. La información sobre el producto se presenta de forma sencilla y clara en la parte posterior para ayudar al consumidor a tomar una decisión informada.



El atractivo diseño del envase proporciona una clara visión del producto en su interior y su estructura resistente protege el contenido durante el envío y también durante la exposición en la tienda.

- Económico
- Menos residuos
- Información clara
- Estructura resistente

Embalaje comercial



Kits de repuestos



Blísters

Conjunto Box



## El código de pedido NARVA

### Abreviaturas del embalaje y códigos



C1/CP  
Embalaje comercial  
**3000**



S2/SM  
Set de dos / Set de dos especial  
**2100**



B1/B2  
Blíster individual / Blíster doble  
**4000**



Pack especial doble para LED  
**3000**

### Abreviaturas para nombres de gamas

- HD** Heavy Duty  
*Resiste todas las vibraciones*
- LL** Long Life  
*Doble vida útil*
- RA** Rallye\*  
*Excelente luminosidad*
- RP50+** Range Power 50+  
*Hasta un 50% más visibilidad*
- RP110** Range Power 110  
*Hasta un 110% más visibilidad*
- RPB+** Range Power Blue+  
*Hasta un 50% más visibilidad, elegante blanco*
- RPW** Range Power White\*  
*4 500 K de xenón blanco*
- RPLED** Range Power LED\*\*  
*Hasta 6000K, luz blanca intensa*

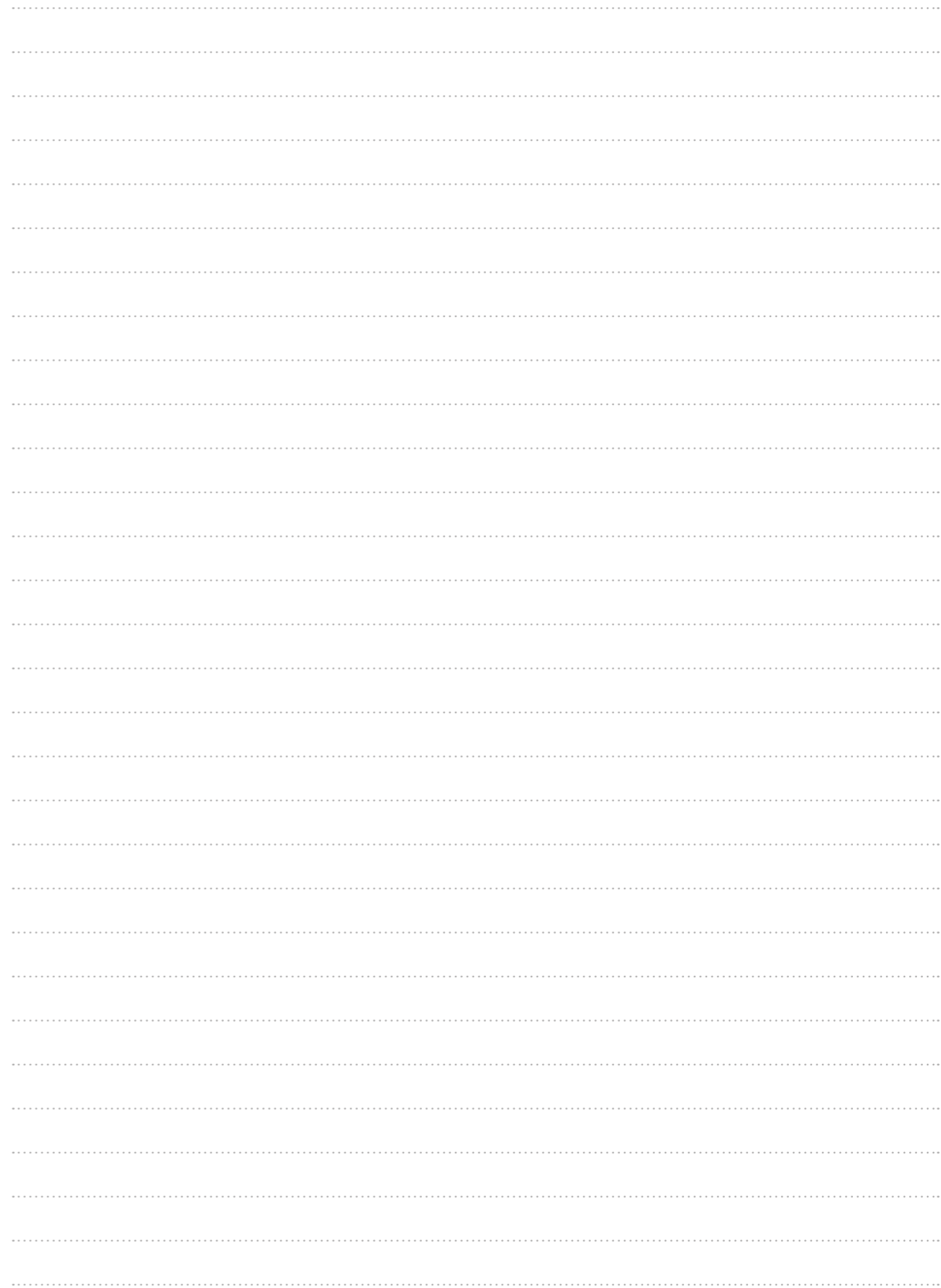
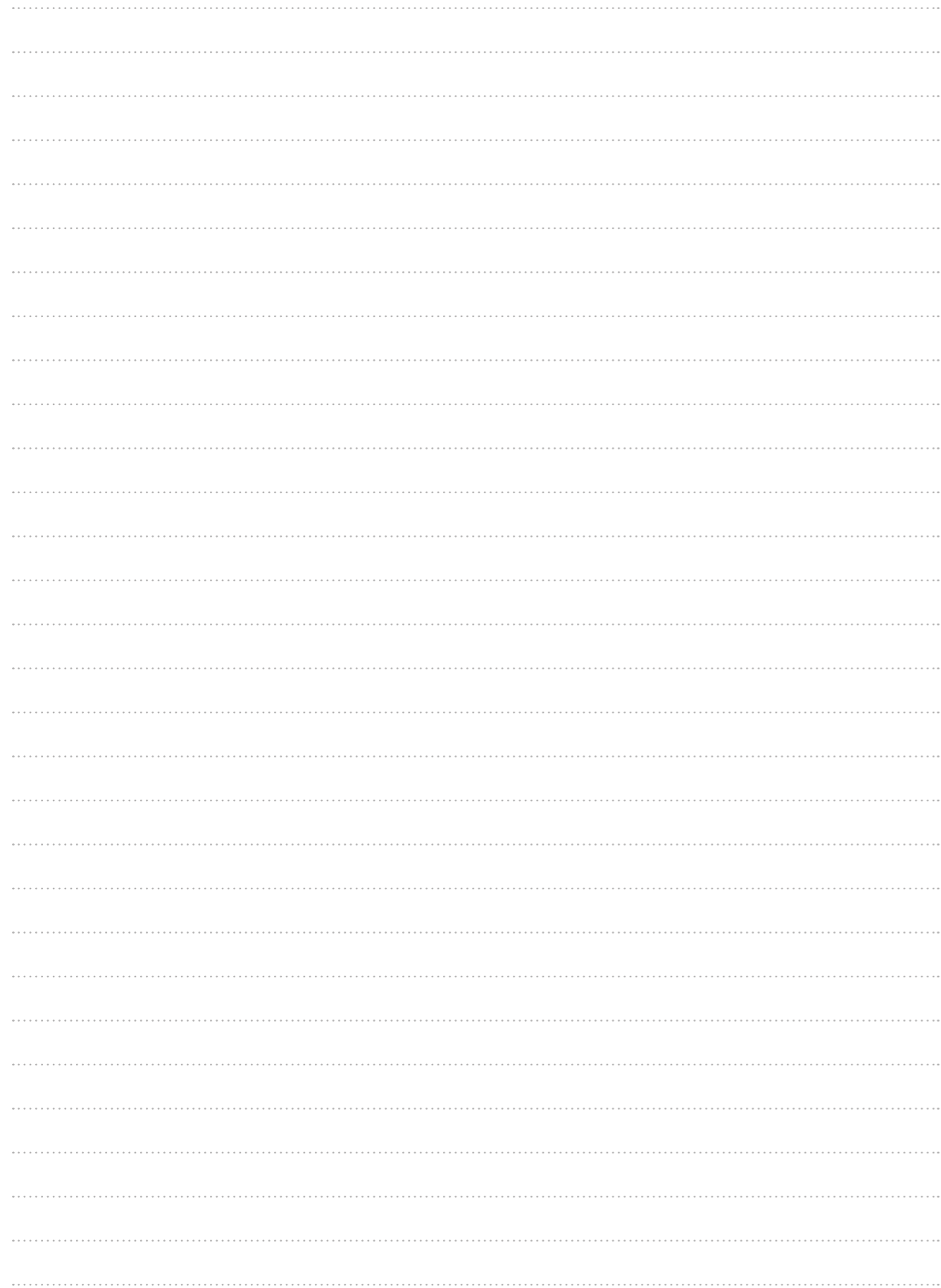



**Lumileds Germany GmbH**

Philipsstraße 8  
52068 Aachen  
Germany

Tel. +49 241 539 3030  
E-mail: [info@narva-light.com](mailto:info@narva-light.com)  
[www.narva-light.com](http://www.narva-light.com)

© 2019 Lumileds Holding B.V.

ES-ES · 0219

Member of **NARVA e.V. Germany** ///